

SPARTA

THE ITALIAN STYLE DOOR



YOUR HOME, YOUR LIFE

FORTI CON STILE STRONG WITH STYLE

*Dierre has designed "Sparta"
for those who love linear shapes
but at the same time wish to enjoy
a degree of strength able to defy time.
"Sparta" offers neat lines that fit
in any architectural surrounding
but that conceal security locks
able to protect your world
from any intrusion.
"Sparta" is available with different panelling
so as to meet any security and solidity need
without having to give up style.*

Dierre ha progettato "Sparta"
per chi ama la semplicità nelle forme
ma desidera al contempo godere di una robustezza
in grado di sfidare il tempo.
"Sparta" offre linee pulite che si adattano
a qualunque contesto architettonico
ma che celano serrature di sicurezza
in grado di proteggere il vostro mondo
da qualsiasi intrusione.
"Sparta" è disponibile in diversi rivestimenti
per soddisfare qualunque esigenza di sicurezza
e solidità senza rinunciare allo stile.





SPARTA 5

Rivestimento in Mogano tinto liscio impiallacciato
Panelling in smooth veneered stained mahogany





SPARTA 8

Rivestimento esterno liscio con cornici applicate, laccato verde Dierre
Smooth external panelling with applied cornices, lacquered Dierre green

LE VERSIONI TYPES

SPARTA is available in the Double Leaf version
for the following types:

SPARTA è disponibile
nella versione Doppio Battente per i modelli:
SPARTA 4
SPARTA 1
SPARTA 11
SPARTA 12

In the Single Leaf version
for the following types:

Nella versione ad un battente
per i modelli:
SPARTA 4
SPARTA 1
SPARTA A
SPARTA 11
SPARTA 12
SPARTA 5
SPARTA 8
SPARTA 9
SPARTA 6
SPARTA 6 Cilindro
SPARTA 10
SPARTA 3
NEW SPARTA 3
SPARTA 13
SPARTA 14

ESEMPI DI REALIZZAZIONE

PRODUCTION EXAMPLES

SPARTA 4 Doppio Battente laccata rossa RAL 3001 con anta semifissa finestrata
SPARTA 4 double leaf lacquered red RAL 3001 with glazed semi-fixed leaf



CHIAVI E MOSTRINE

Tutte le referenze vi permettono di inserirle in ogni tipo di ambiente. Grazie alla loro estrema versatilità, alle molteplici varianti di colore e rivestimento e ai numerosi dettagli, faranno un'ottima figura in qualsiasi situazione. SPARTA offre, a seconda del modello, due varianti di chiavi: Cilindro o Doppia Mappa.

Disponibili nella versione bronzo, argento e vero ottone.

SPARTA 1 - SPARTA 8 - SPARTA 6 Cilindro



LATO INTERNO
INTERNAL SIDE



LATO ESTERNO
OUTSIDE

SPARTA 4 - SPARTA 5 - SPARTA 6



LATO INTERNO
INTERNAL SIDE



LATO ESTERNO
EXTERNAL SIDE

SPARTA 12 - SPARTA 9 - SPARTA 13



LATO INTERNO
INTERNAL SIDE



LATO ESTERNO
EXTERNAL SIDE

NEW SPARTA 3 - SPARTA 11 - SPARTA A
SPARTA 10 - SPARTA 14



LATO INTERNO
INTERNAL SIDE



LATO ESTERNO
EXTERNAL SIDE

SISTEMI DI CHIUSURA LOCKING SYSTEMS

SERRATURE PER CILINDRO / LOCKS FOR CYLINDER

LOCK
blocking system

Frutto della costante ricerca Dierre, Lock Blocking System è la sintesi perfetta di tecnologia, qualità e innovazione. Questo sistema permette di bloccare la serratura qualora si cercasse di strappare il cilindro con la tecnica distruttiva volgarmente chiamata “attacco del tubo”.

Deriving from Dierre's ongoing research, Lock Blocking System is the perfect blend between technology, quality and innovation. This system allows to block the lock in the event of an attempt of wrenching the cylinder with the technique normally called “snap attack”.



SERRATURE A DOPPIA MAPPA / LOCKS DOUBLE BIT

LOCK
trap system

Frutto della costante ricerca Dierre, Lock Trap System è la sintesi perfetta di tecnologia, qualità e innovazione. Come funziona? In caso di tentata effrazione, il sistema interviene e blocca la serratura, ma, una volta estratto lo strumento di manomissione, libera il meccanismo e consente la normale apertura. Lock Trap System ha superato le severe prove di anti-

manipolazione previste dal marchio A2P** riconosciuto dal prestigioso istituto di prevenzione e controllo dei rischi CNPP.

*Thanks to constant research, Dierre's Lock Trap System is the perfect synthesis of technology, quality and innovation. How does it work? In case of burglary attempt, the system is activated and blocks the latch, but, once the burglary tool has been extracted, it is automatically disabled, allowing to normally open the door. Lock Trap System passed strict anti-manipulation tests required by the A2P** brand recognised by the renowned CNPP Risk Control and Prevention Institute.*



Anche Lock Trap System utilizza il brevetto MIA che, in caso di furto o smarrimento delle chiavi, consente la rapida e semplice sostituzione del blocchetto centrale.

Also Lock Trap System employs MIA patented technology that, in case of theft or loss, allows to replace the central block quickly.

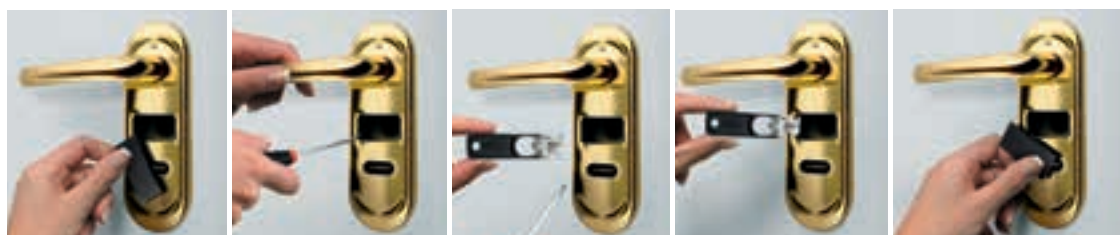

Rimuovere la copertura di plastica.
Remove the plastic cover.

Con un cacciavite svitare le due viti che fissano il blocchetto.
Unscrew with a screwdriver the two screws that fix the block.

Aprire l'astuccio contenente il blocchetto personalizzato e le chiavi in dotazione. Con l'apposito estrattore che trovate nella scatola, togliere il blocchetto.
Open the pack containing the personalized block and the provided keys. Remove the block with the extractor that you'll find in the box.

Inserire il nuovo blocchetto e riavvitare le due viti di fissaggio.
Insert the new block and screw back on the two fixing screws.

Richiudere la copertura di plastica.
Close the plastic cover.



SPARTA 4 - SPARTA 5 - SPARTA 6

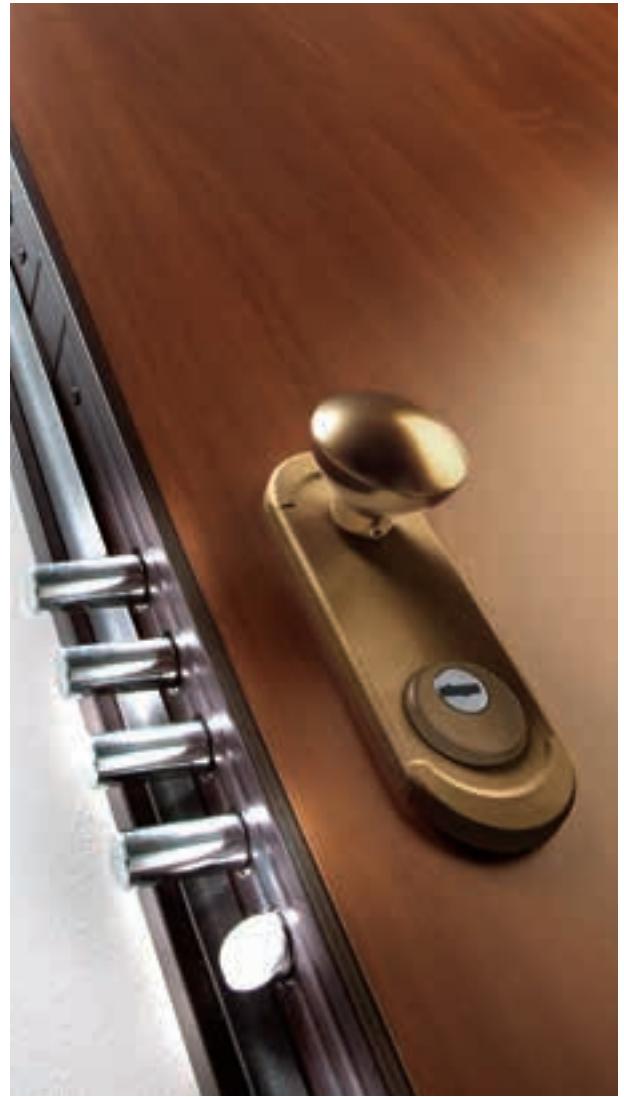

SPARTA 1 - SPARTA 8 - SPARTA 6 Cilindro



CARENATURA A GRAFFA
CLIP-ON TRIMMING



ROSTRI FISSI
FIXED GRIPS

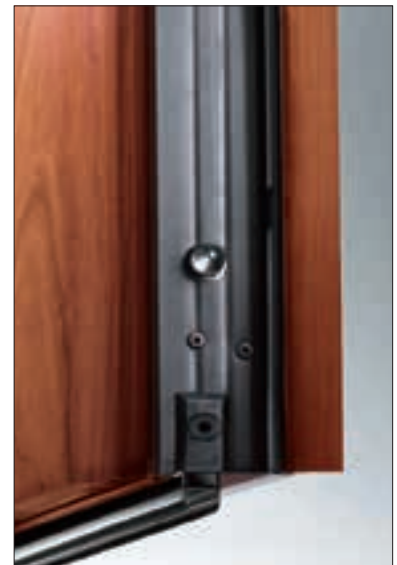

LAMINA PARAFREDDO
DRAUGHT EXCLUDING SILL

DETTAGLI DI SICUREZZA SECURITY DETAILS

Ciò che distingue una porta normale dalle porte blindate è il livello di sicurezza offerto.

Ma per garantire standard così elevati la porta deve essere curata nei minimi dettagli. A rendere più solida SPARTA possono intervenire due tipi di serrature.

La serratura a Doppia Mappa, dotata di sistema Lock Trap System, uno dei più tradizionali ed efficaci sistemi di chiusura per porte blindate, si caratterizza di una chiave sagomata in modo univoco su ciascuno dei due lati, così da renderla quasi impossibile da riprodurre.

La serratura a Cilindro, dotata di sistema Lock Blocking System, è il tipo di chiusura più diffuso in Europa. Consiste in una chiave sagomata che andrà a ruotare all'interno di un dispositivo cilindrico. Questo è dotato di una speciale protezione contro lo strappo dall'esterno, di una piastra anti trapano, ed inoltre, grazie alla fessura dimensionata per la sola chiave, il dispositivo è protetto anche dagli arnesi da scasso.

The difference that stands out between a normal door and a security door is the level of security they offer. So as to ensure such high standards every single small detail of the door must be cared for. Two types of locks may intervene to make SPARTA more solid.

The double bit lock, one of the most traditional and efficient locking systems for security doors, features an individually shaped key on each of the two sides, so as to make it almost impossible to reproduce.

The cylinder lock is the most widespread locking type in Europe. It consist of a shaped key that rotates within a cylindrical device. This is equipped with a special protection to prevent wrenching from the outside, of a drill-resistant plate and also, thanks to the opening dimensioned for the key only, the device is protected also from burglar tools.

RIVESTIMENTI PANELLING

Discover the wide range of available panelling for your security door: request the catalogue from your Dierre Partner.

Scopri la vasta gamma di rivestimenti disponibili per la tua porta di sicurezza: richiedi il catalogo al tuo Dierre Partner.



PRINT WOOD

IDENTITY PANELLING

Con il nuovo pannello di rivestimento Printwood personalizzi la tua porta blindata in modo originale e distintivo, scegliendo fra le suggestive immagini suggerite da Dierre oppure con una foto realizzata e proposta da te.

With the new Printwood panelling you can customize your security door in an original and distinctive way, choosing amongst the inspiring pictures Dierre suggests or with a photo you took and proposed.

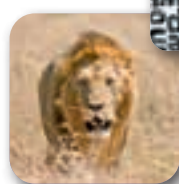

SPARTA: REALIZZATA SU MISURA PER VOI



UN BATTENTE DIAGONALE
SLANTED SINGLE LEAF



UN BATTENTE A SESTO
ARCHED SINGLE LEAF



UN BATTENTE A SESTO RIBASSATO
REDUCED ARCH SINGLE LEAF



UN BATTENTE CON SOPRALUCE
SINGLE LEAF WITH FANLIGHT



UN BATTENTE CON SOPRALUCE A SESTO CON GRATA
SINGLE LEAF WITH ARCHED FANLIGHT WITH GRILLE



UN BATTENTE CON SOPRALUCE A SESTO RIBASSATO
SINGLE LEAF WITH LOWERED ARCH FANLIGHT



UN BATTENTE CON SINGOLO FIANCOLUCE
SINGLE LEAF WITH SIDELIGHT



UN BATTENTE CON SOPRALUCE E SINGOLO FIANCOLUCE
SINGLE LEAF WITH FANLIGHT AND ONE SIDELIGHT



UN BATTENTE CON SOPRALUCE E DOPPIO FIANCOLUCE
SINGLE LEAF WITH FANLIGHT AND DOUBLE SIDELIGHT



UN BATTENTE CON SOPRALUCE A SESTO RIBASSATO E DOPPIO FIANCOLUCE
SINGLE LEAF WITH LOWERED ARCH FANLIGHT AND DOUBLE SIDELIGHT

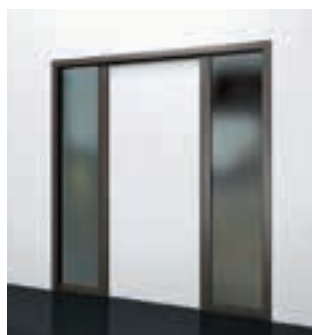

UN BATTENTE CON DOPPIO FIANCOLUCE
SINGLE LEAF WITH DOUBLE SIDELIGHT



UN BATTENTE CON SOPRALUCE A SESTO E DOPPIO FIANCOLUCE
SINGLE LEAF WITH ARCH FANLIGHT AND DOUBLE SIDELIGHT

SPARTA: MADE TO MEASURE FOR YOU



DOPPIO BATTENTE
DOUBLE LEAF



DOPPIO BATTENTE CON SOPRALUCE
DOUBLE LEAF WITH FANLIGHT



DOPPIO BATTENTE CON SINGOLO
FIANCOLUCE
DOUBLE LEAF WITH SINGLE SIDE-
LIGHT



DOPPIO BATTENTE CON SOPRALUCE E
SINGOLO FIANCOLUCE
DOUBLE LEAF WITH FANLIGHT AND
SINGLE SIDELIGHT



DOPPIO BATTENTE CON SOPRALUCE
E DOPPIO FIANCOLUCE
DOUBLE LEAF WITH FANLIGHT AND
DOUBLE SIDELIGHT



DOPPIO BATTENTE CON DOPPIO
FIANCOLUCE
DOUBLE LEAF WITH DOUBLE
SIDELIGHT



DOPPIO BATTENTE CON SOPRALUCE A
SESTO RIBASSATO
DOUBLE LEAF WITH LOWERED
ARCHED FANLIGHT



DOPPIO BATTENTE CON SOPRALUCE
A SESTO
DOUBLE LEAF WITH ARCHED
FANLIGHT



DOPPIO BATTENTE CON SOPRALUCE A
SESTO RIBASSATO, DOPPIO FIANCOLUCE
DOUBLE LEAF WITH LOWERED ARCHED
FANLIGHT, DOUBLE SIDELIGHT



DOPPIO BATTENTE CON SOPRALUCE A
SESTO E DOPPIO FIANCOLUCE
DOUBLE LEAF WITH ARCHED FANLIGHT AND
DOUBLE SIDELIGHT



DOPPIO BATTENTE CON SOPRALUCE E
DOPPIO FIANCOLUCE
DOUBLE LEAF WITH FANLIGHT AND
DOUBLE SIDELIGHT



DOPPIO BATTENTE CON SOPRALUCE
A SESTO CON GRATA
DOUBLE LEAF WITH ARCHED
FANLIGHT WITH GRILLE

SPARTA DOPPIA LAMIERA: RAPPRESENTAZIONE GRAFICA DEL BATTENTE

DOUBLE SHEET SPARTA: DRAWING OF THE LEAF

SPARTA 1

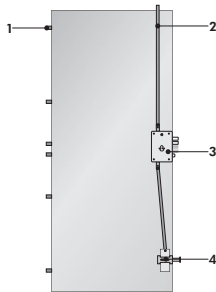

- 1: n°6 rostri fissi shild
 - 2: Asta superiore
 - 3: Serratura triplice a cilindro
 - 4: Deviatore "Artiglio"
- 1 - 6 shild grips
2 - Upper rod
3 - Triple cylinder lock
4 - "Artiglio" deviator

SPARTA 1 D.B.

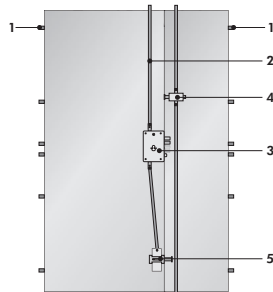

- 1: n°6+6 rostri fissi shild
 - 2: Asta superiore
 - 3: Serratura triplice a cilindro
 - 4: Dispositivo di chiusura Anta Semifissa
 - 5: Deviatore "Artiglio"
- 1 - 6+6 shild grips
2 - Upper rod
3 - Triple cylinder lock
4 - Semi-fixed leaf closure device
5 - "Artiglio" deviator

SPARTA 4

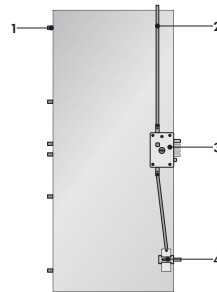

- 1: n°6 rostri fissi shild
 - 2: Asta superiore
 - 3: Serratura triplice doppia mappa
 - 4: Deviatore "Block"
- 1 - 6 shild grips
2 - Upper rod
3 - Triple double bit lock
4 - "Block" deviator

SPARTA 4 D.B.

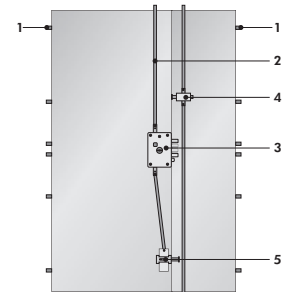

- 1: n°6+6 rostri fissi shild
 - 2: Asta superiore
 - 3: Serratura triplice doppia mappa
 - 4: Dispositivo di chiusura Anta Semifissa
 - 5: Deviatore "Artiglio"
- 1 - 6+6 shild grips
2 - Upper rod
3 - Triple double bit lock
4 - Semi-fixed leaf closure device
5 - "Artiglio" deviator

SPARTA A

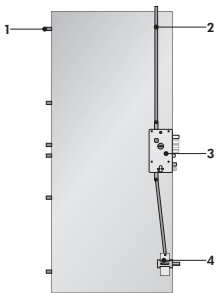

- 1: n°6 rostri fissi shild
 - 2: Asta superiore
 - 3: Serratura triplice doppia mappa + cilindro inferiore di servizio
 - 4: Deviatore "Block"
- 1 - 6 shild grips
2 - Upper rod
3 - Triple double bit lock + lower service cylinder
4 - "Block" deviator

SPARTA 11

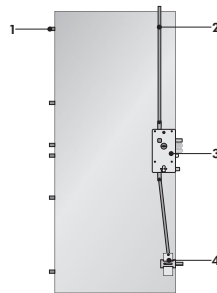

- 1: n°6 rostri fissi shild
 - 2: Asta superiore
 - 3: Serratura triplice doppia mappa + cilindro inferiore di servizio
 - 4: Deviatore "Block"
- 1 - 6 shild grips
2 - Upper rod
3 - Triple double bit lock + lower service cylinder
4 - "Block" deviator

SPARTA 12

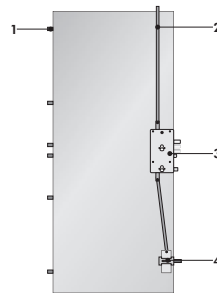

- 1: n°6 rostri fissi shild
 - 2: Asta superiore
 - 3: Serratura triplice: cilindro superiore di sicurezza + cilindro inferiore di servizio
 - 4: Deviatore "Block"
- 1 - 6 shild grips
2 - Upper rod
3 - Triple lock with: upper security cylinder; lower service cylinder
4 - "Block" deviator

SPARTA 11 D.B.

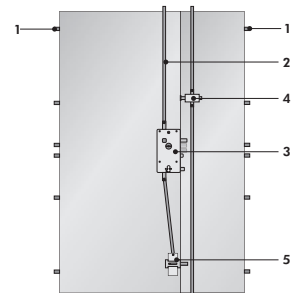

- 1: n°6+6 rostri fissi shild
 - 2: Asta superiore
 - 3: Serratura triplice doppia mappa + cilindro inferiore di servizio
 - 4: Dispositivo di chiusura Anta Semifissa
 - 5: Deviatore "Block"
- 1 - 6+6 shild grips
2 - Upper rod
3 - Triple double bit lock + lower service cylinder
4 - Semi-fixed leaf closure device
5 - "Block" deviator

SPARTA 12 D.B.

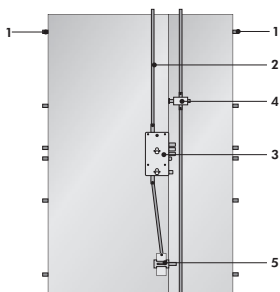

- 1: n°6+6 rostri fissi shild
 - 2: Asta superiore
 - 3: Serratura triplice: cilindro superiore di sicurezza + cilindro inferiore di servizio
 - 4: Dispositivo di chiusura Anta Semifissa
 - 5: Deviatore "Block"
- 1 - 6+6 shild grips
2 - Upper rod
3 - Triple lock with: upper security cylinder; lower service cylinder
4 - Semi-fixed leaf closure device
5 - "Block" deviator

SPARTA MONOLAMIERA: RAPPRESENTAZIONE GRAFICA DEL BATTENTE

SINGLE SHEET SPARTA: DRAWING OF THE LEAF

SPARTA 10

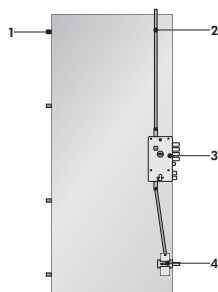

- 1: n°4 rostri fissi
- 2: Asta superiore
- 3: Serratura triplice doppia mappa + cilindro inferiore di sicurezza
- 4: Deviatore "Block"

- 1 - 4 fixed grips
- 2 - Upper rod
- 3 - Triple double bit lock + lower security cylinder
- 4 - "Block" deviator

SPARTA 9

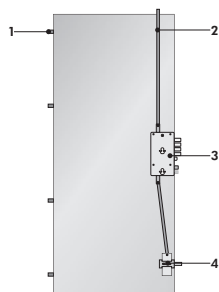

- 1: n°4 rostri fissi
- 2: Asta superiore
- 3: Serratura triplice: cilindro superiore di sicurezza + cilindro inferiore di servizio
- 4: Deviatore "Block"

- 1 - 4 fixed grips
- 2 - Upper rod
- 3 - Triple lock with: upper security cylinder; lower service cylinder
- 4 - "Block" deviator

NEW SPARTA 3

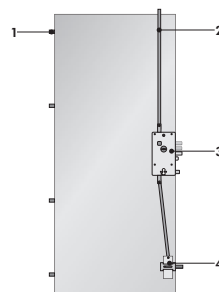

- 1: n°4 rostri fissi
- 2: Asta superiore
- 3: Serratura triplice doppia mappa + cilindro inferiore di servizio
- 4: Deviatore "Block"

- 1 - 4 fixed grips
- 2 - Upper rod
- 3 - Triple double bit lock + lower service cylinder
- 4 - "Block" deviator

SPARTA 3

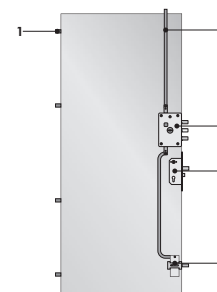

- 1: n°4 rostri fissi
- 2: Asta superiore
- 3: Serratura triplice doppia mappa
- 4: Serratura di servizio
- 5: Deviatore "Block"

- 1 - 4 fixed grips
- 2 - Upper rod
- 3 - Triple double bit lock
- 4 - Lower service cylinder
- 5 - "Block" deviator

SPARTA 5

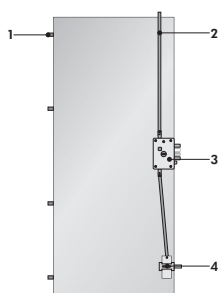

- 1: n°4 rostri fissi
- 2: Asta superiore
- 3: Serratura triplice doppia mappa
- 4: Deviatore "Block"

- 1 - 4 fixed grips
- 2 - Upper rod
- 3 - Triple double bit lock
- 4 - "Block" deviator

SPARTA 8

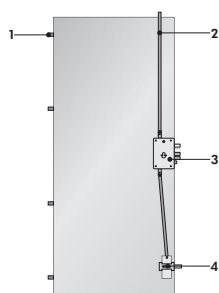

- 1: n°4 rostri fissi
- 2: Asta superiore
- 3: Serratura triplice a cilindro
- 4: Deviatore "Block"

- 1 - 4 fixed grips
- 2 - Upper rod
- 3 - Triple cylinder lock
- 4 - "Block" deviator

SPARTA 6

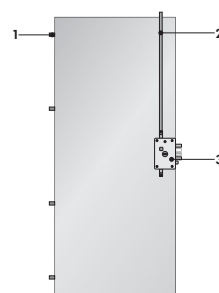

- 1: n°4 rostri fissi
- 2: Asta superiore
- 3: Serratura triplice doppia mappa

- 1 - 4 fixed grips
- 2 - Upper rod
- 3 - Triple double bit lock

SPARTA 6 A CILINDRO

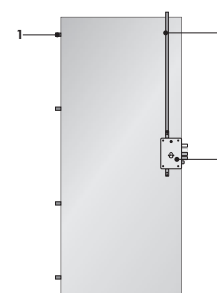

- 1: n°4 rostri fissi
- 2: Asta superiore
- 3: Serratura triplice a cilindro

- 1 - 4 fixed grips
- 2 - Upper rod
- 3 - Triple cylinder lock

SPARTA 13

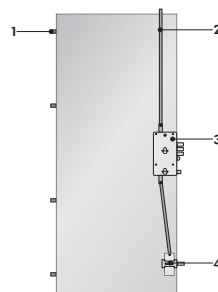

- 1: n°4 rostri fissi
- 2: Asta superiore
- 3: Serratura triplice: cilindro superiore di sicurezza + cilindro inferiore di servizio
- 4: Deviatore "Block"

- 1 - 4 fixed grips
- 2 - Upper rod
- 3 - Triple lock with: upper security cylinder; lower service cylinder
- 4 - "Block" deviator

SPARTA 14

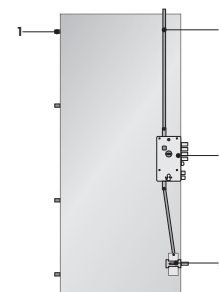

- 1: n°4 rostri fissi
- 2: Asta superiore
- 3: Serratura triplice doppia mappa + cilindro di sicurezza (indipendenti)
- 4: Deviatore "block"

- 1 - 4 fixed grips
- 2 - Upper rod
- 3 - Triple double bit lock + security cylinder (independent locks)
- 4 - "Block" deviator

CARATTERISTICHE PRESTAZIONALI

PERFORMANCE FEATURES



ABBATTIMENTO TERMICO THERMAL INSULATION
 da 1.8 a 0.9 w/m².k - EN ISO 100771 (SPARTA DPL)
 da 2.2 a 1.1 w/m².k - EN ISO 100771 (SPARTA MNL)
 from 1.8 to 0.9 w/m².k - EN ISO 100771 (SPARTA DPL)
 from 2.2 to 1.1 w/m².k - EN ISO 100771 (SPARTA MNL)



ABBATTIMENTO ACUSTICO SOUND INSULATION
 da 35 dB a 40 dB - EN ISO 140/3, EN ISO 717-1 (SPARTA MNL)
 da 38 dB a 45 dB - EN ISO 140/3, EN ISO 717-1 (SPARTA DPL)
 from 35 dB to 40 dB - EN ISO 140/3, EN ISO 717-1 (SPARTA MNL)
 from 38 dB to 45 dB - EN ISO 140/3, EN ISO 717-1 (SPARTA DPL)



RESISTENZA ALL'EFFRAZIONE BREAK-IN RESISTANCE
 Classe 2 - ENV 1627 (SPARTA MNL)
 Classe 3 - ENV 1627 (SPARTA DPL)
 Classe 2 - ENV 1627 (SPARTA MNL)
 Classe 3 - ENV 1627 (SPARTA DPL)



TENUTA AL VENTO RESISTANCE TO WIND LOAD
 fino a classe C5 - UNI EN 12210
 up to class C5 - UNI EN 12210



PERMEABILITÀ ALL'ARIA AIR PERMEABILITY
 fino a classe 4 - UNI EN 12207
 up to class 4 - UNI EN 12207



TENUTA ACQUA WATERTIGHTNESS
 fino a classe 8 A - UNI EN 12208
 up to class 8 A - UNI EN 12208

MISURE TELAIO E CONTROTELAIO

FRAME AND SUBFRAME DIMENSIONS

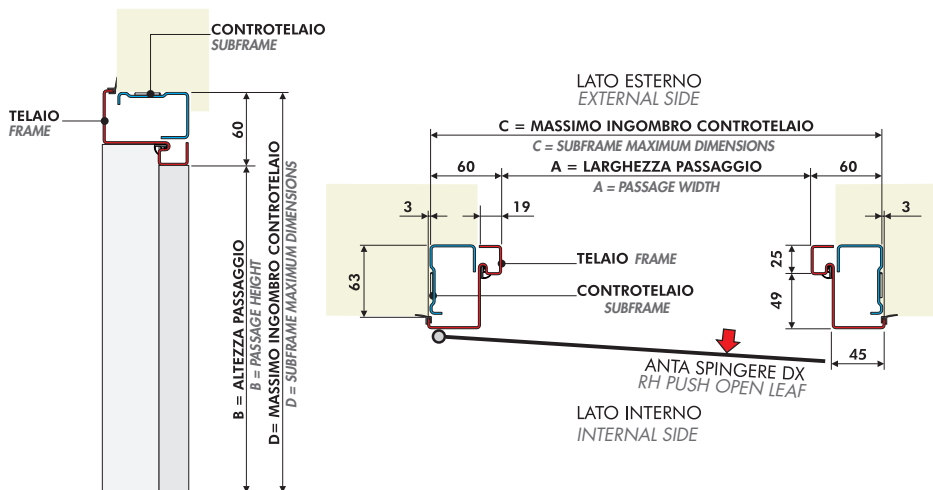

MISURE STANDARD PER IL TELAIO E CONTROTELAIO SPARTA DPL
STANDARD DIMENSIONS FOR FRAME AND SUBFRAME SPARTA DPL

MISURE PER TELAIO STANDARD + CONTROTELAIO STANDARD DIMENSIONS FOR STANDARD FRAME + STANDARD SUBFRAME

A	B	C	D
900	2100	1020	2160
850	2100	970	2160
800	2100	920	2160
900	2200	1020	2260
850	2200	970	2260
800	2200	920	2260

COME RICAVARE LE MISURE: HOW TO OBTAIN THE DIMENSIONS:

LARGHEZZA VANO MURO WALL OPENING WIDTH	1030
GIOCO D'USO USE PLAY	10
60	60
60	60

A LARGHEZZA PASSAGGIO (LNL) A PASSAGE WIDTH (LNL)

ALTEZZA VANO MURO WALL OPENING HEIGHT	2170
GIOCO D'USO USE PLAY	10
60	60

B ALTEZZA PASSAGGIO (LNH) B PASSAGE HEIGHT (LNH)

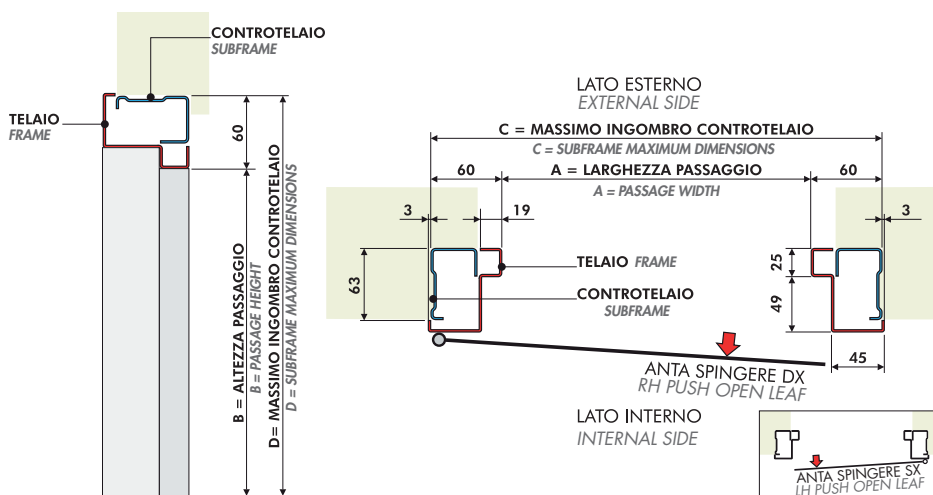

MISURE STANDARD PER IL TELAIO E CONTROTELAIO SPARTA MNL
STANDARD DIMENSIONS FOR FRAME AND SUBFRAME SPARTA MNL

MISURE PER TELAIO STANDARD + CONTROTELAIO STANDARD DIMENSIONS FOR STANDARD FRAME + STANDARD SUBFRAME

A	B	C	D
900	2100	1020	2160
850	2100	970	2160
800	2100	920	2160
900	2200	1020	2260
850	2200	970	2260
800	2200	920	2260

COME RICAVARE LE MISURE: HOW TO OBTAIN THE DIMENSIONS:

LARGHEZZA VANO MURO WALL OPENING WIDTH	1030
GIOCO D'USO USE PLAY	10
60	60
60	60

A LARGHEZZA PASSAGGIO (LNL) A PASSAGE WIDTH (LNL)

ALTEZZA VANO MURO WALL OPENING HEIGHT	2170
GIOCO D'USO USE PLAY	10
60	60

B ALTEZZA PASSAGGIO (LNH) B PASSAGE HEIGHT (LNH)

MISURE TELAIO E CONTROTELAIO FRAME AND SUBFRAME DIMENSIONS

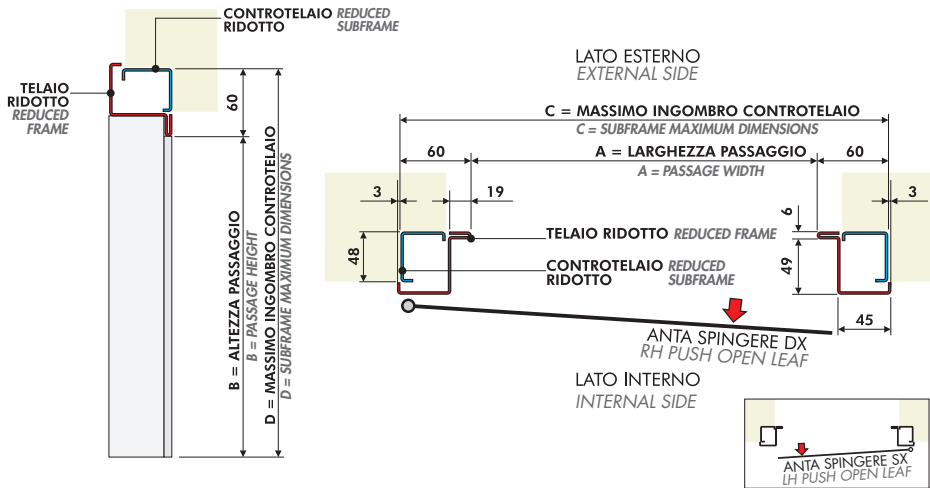

MISURE STANDARD PER IL TELAIO E CONTROTELAIO RIDOTTI
STANDARD DIMENSIONS FOR REDUCED FRAME AND SUBFRAME

MISURE PER TELAIO RIDOTTO + CONTROTELAIO RIDOTTO DIMENSIONS FOR REDUCED FRAME + REDUCED SUBFRAME

	A	B	C	D
	900	2100	1020	2160
	850	2100	970	2160
	800	2100	920	2160
	900	2200	1020	2260
	850	2200	970	2260
	800	2200	920	2260

COME RICAVARE LE MISURE: HOW TO OBTAIN THE DIMENSIONS:

LARGHEZZA VANO MURO WALL OPENING WIDTH	1030
GIOCO D'USO USE PLAY	10
60	60
60	60

A LARGHEZZA PASSAGGIO (LNL) 900
A PASSAGE WIDTH (LNL)

ALTEZZA VANO MURO WALL OPENING HEIGHT	2170
GIOCO D'USO USE PLAY	10
60	60

B ALTEZZA PASSAGGIO (LNH) 2100
B PASSAGE HEIGHT (LNH)

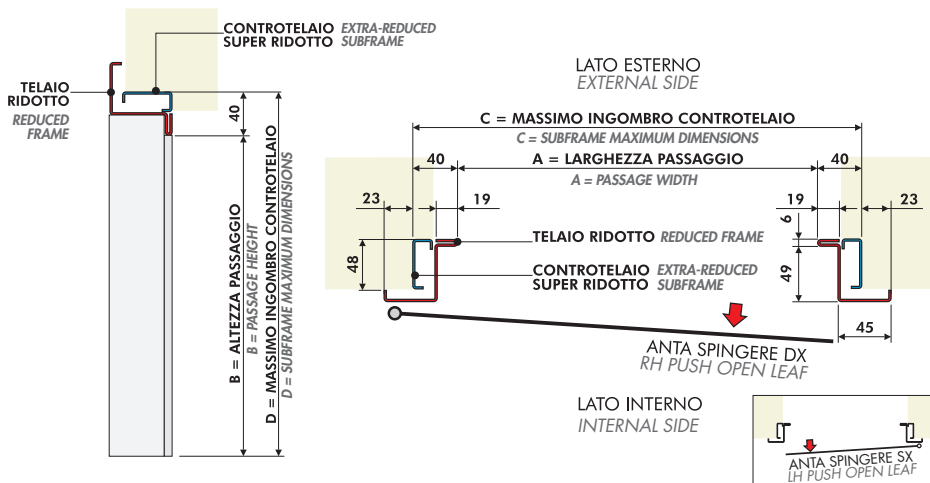

MISURE STANDARD PER IL TELAIO RIDOTTO E CONTROTELAIO SUPER RIDOTTO
STANDARD DIMENSIONS FOR REDUCED FRAME AND SUPER-REDUCED SUBFRAME

MISURE PER TELAIO RIDOTTO + CONTROTELAIO SUPERRIDOTTO DIMENSIONS FOR REDUCED FRAME + REDUCED SUBFRAME

	A	B	C	D
	900	2100	980	2140
	850	2100	930	2140
	800	2100	880	2140
	900	2200	980	2240
	850	2200	930	2240
	800	2200	880	2240

COME RICAVARE LE MISURE: HOW TO OBTAIN THE DIMENSIONS:

LARGHEZZA VANO MURO WALL OPENING WIDTH	990
GIOCO D'USO USE PLAY	10
40	40
40	40

A LARGHEZZA PASSAGGIO (LNL) 900
A PASSAGE WIDTH (LNL)

ALTEZZA VANO MURO WALL OPENING HEIGHT	2150
GIOCO D'USO USE PLAY	10
40	40

B ALTEZZA PASSAGGIO (LNH) 2100
B PASSAGE HEIGHT (LNH)

SPARTA DOPPIA LAMIERA E LA SUA PERFETTA INSTALLAZIONE

DOUBLE SHEET SPARTA AND ITS PERFECT INSTALLATION

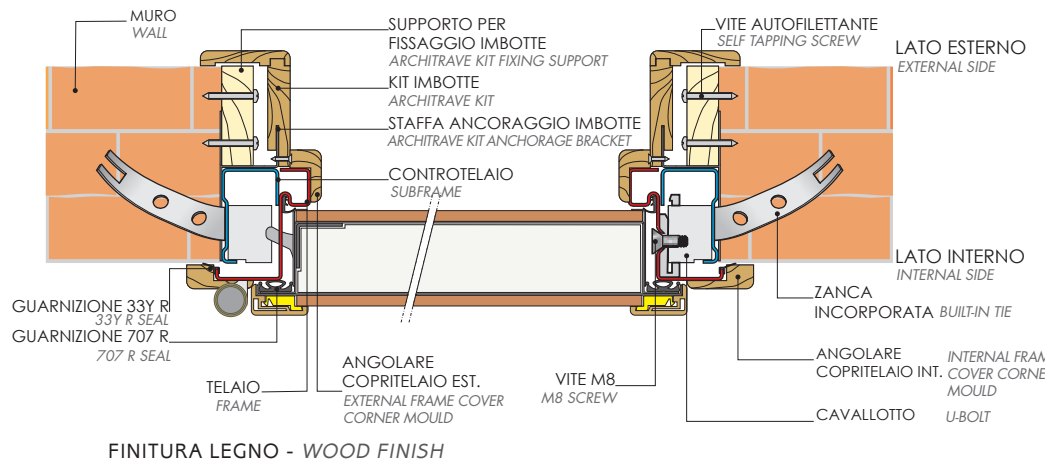
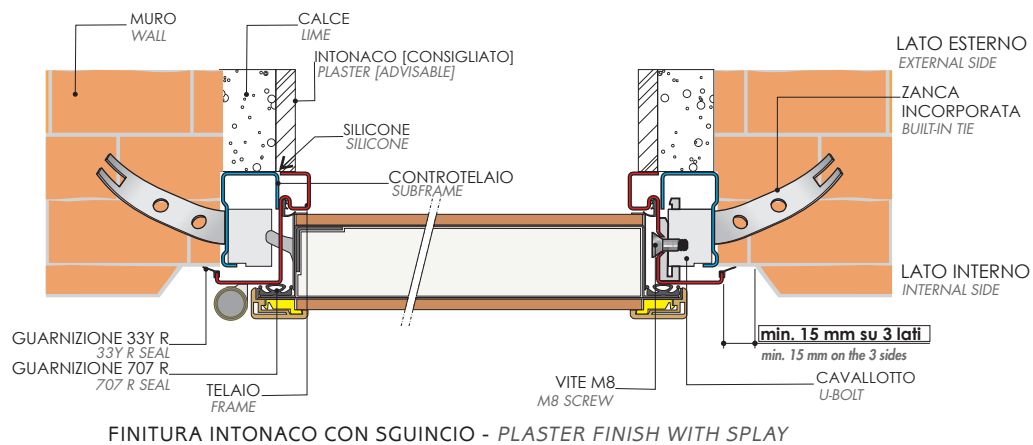
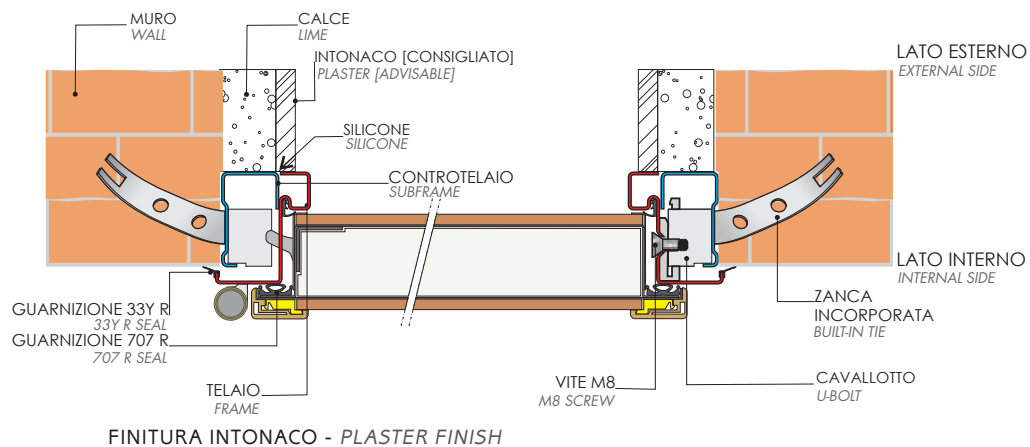
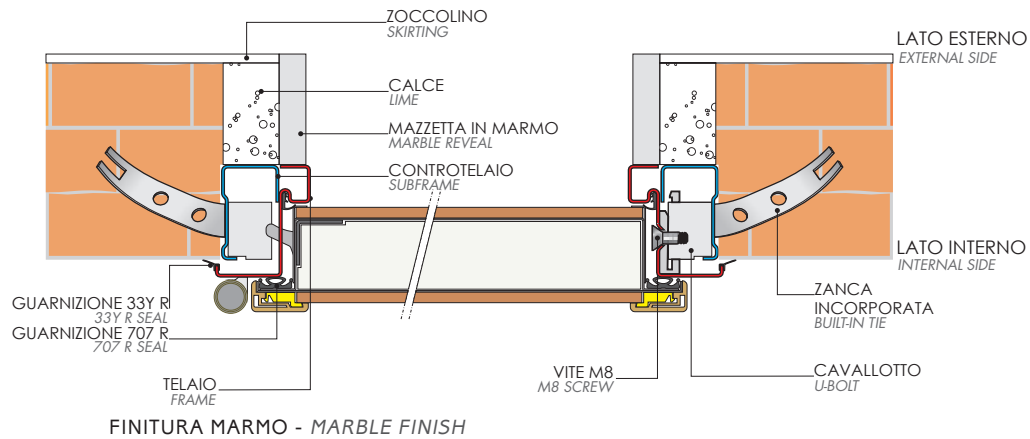

SPARTA MONOLAMIERA E LA SUA PERFETTA INSTALLAZIONE

SINGLE SHEET SPARTA AND ITS PERFECT INSTALLATION

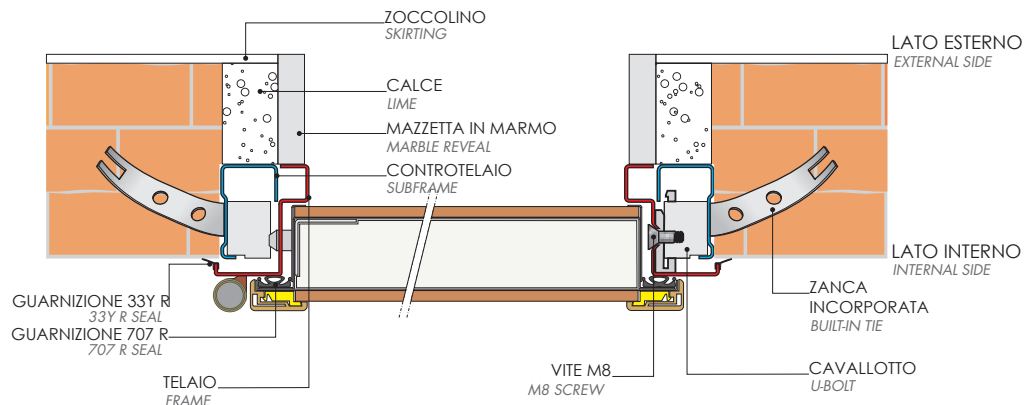

FINITURA MARMO - MARBLE FINISH

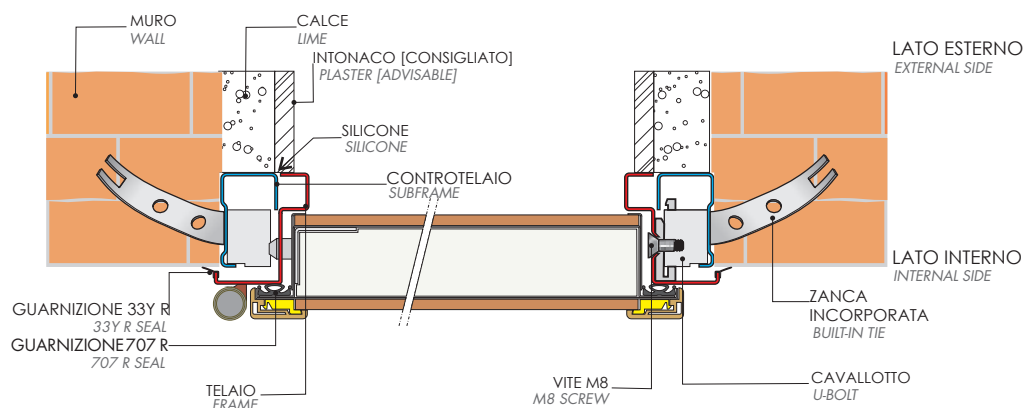

FINITURA INTONACO - PLASTER FINISH

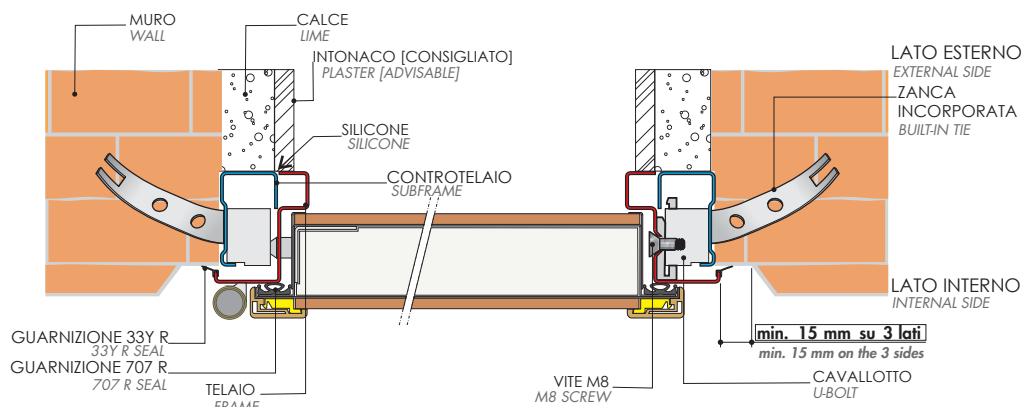

FINITURA INTONACO CON SGUINCIO - PLASTER FINISH WITH SPLAY

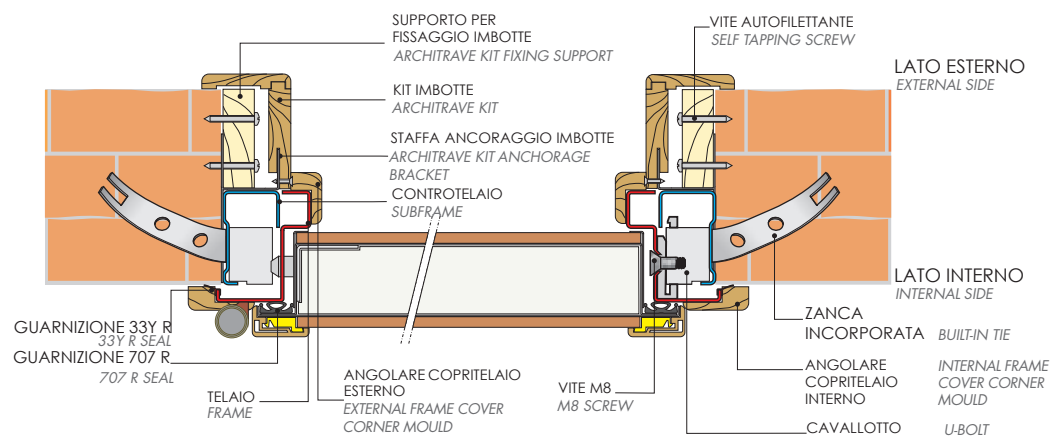

FINITURA LEGNO - WOOD FINISH

SPARTA DOPPIA LAMIERA - SCHEMA TECNICO UN BATTENTE

DOUBLE SHEET SPARTA - TECHNICAL DRAWING SINGLE LEAF

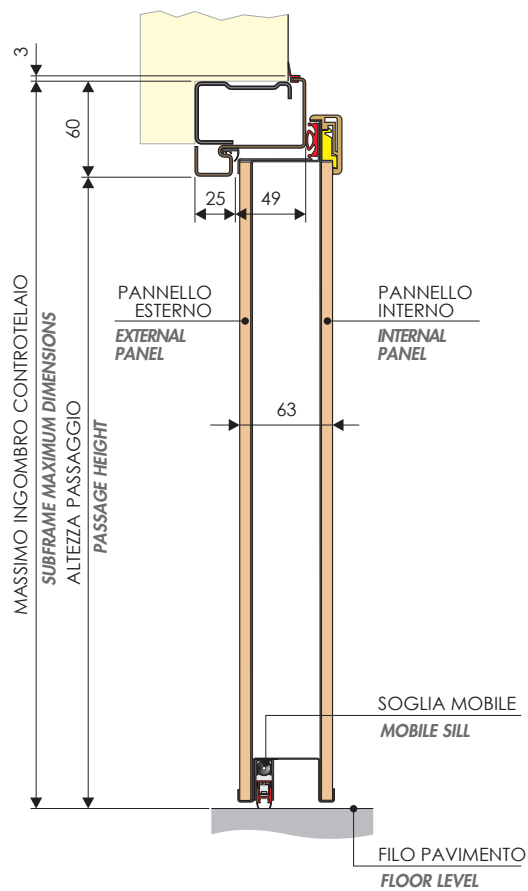
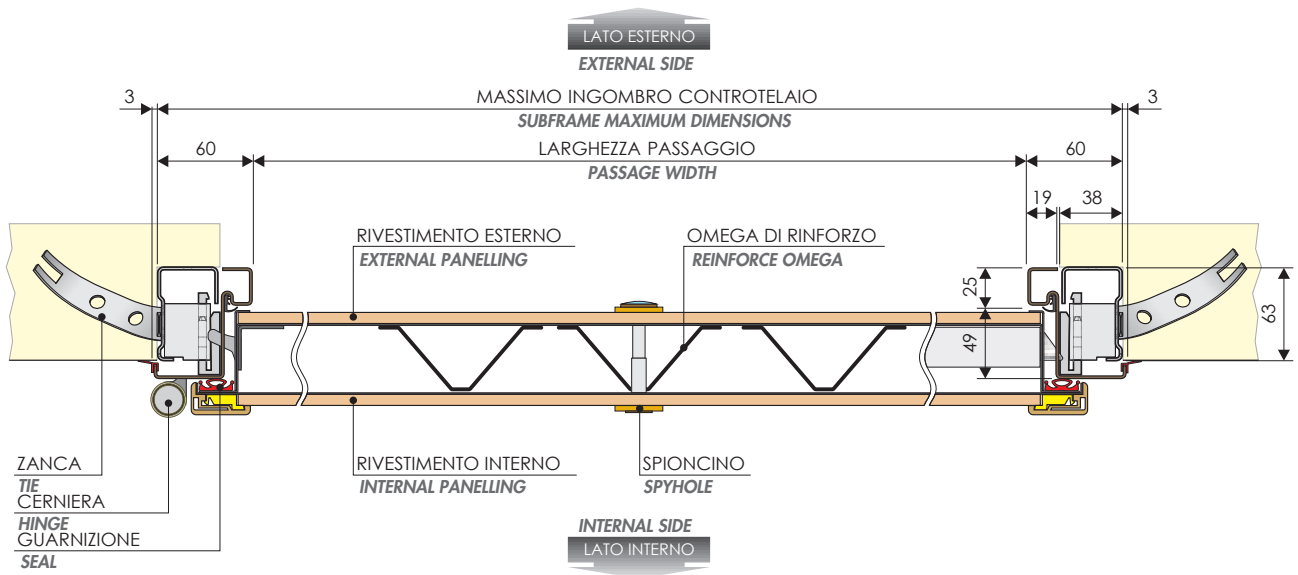

SPARTA DOPPIA LAMIERA - SCHEMA TECNICO DOPPIO BATTENTE

DOUBLE SHEET SPARTA - TECHNICAL DRAWING DOUBLE LEAF

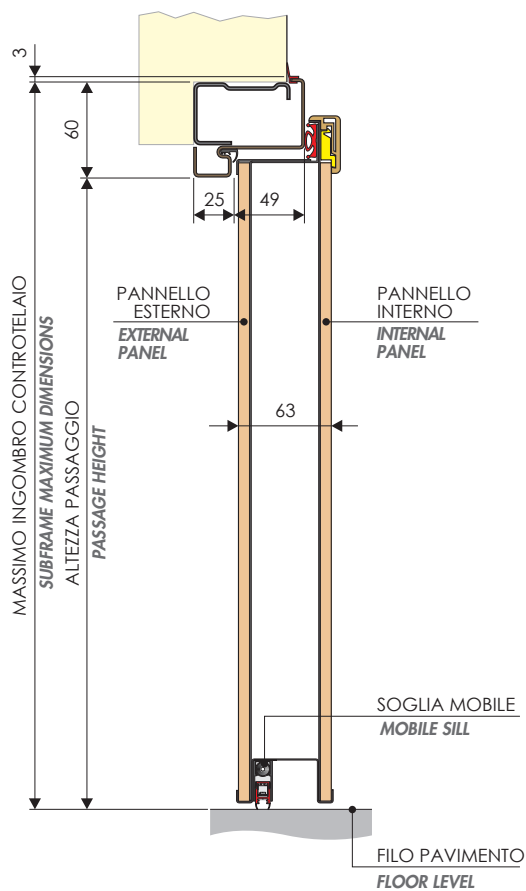
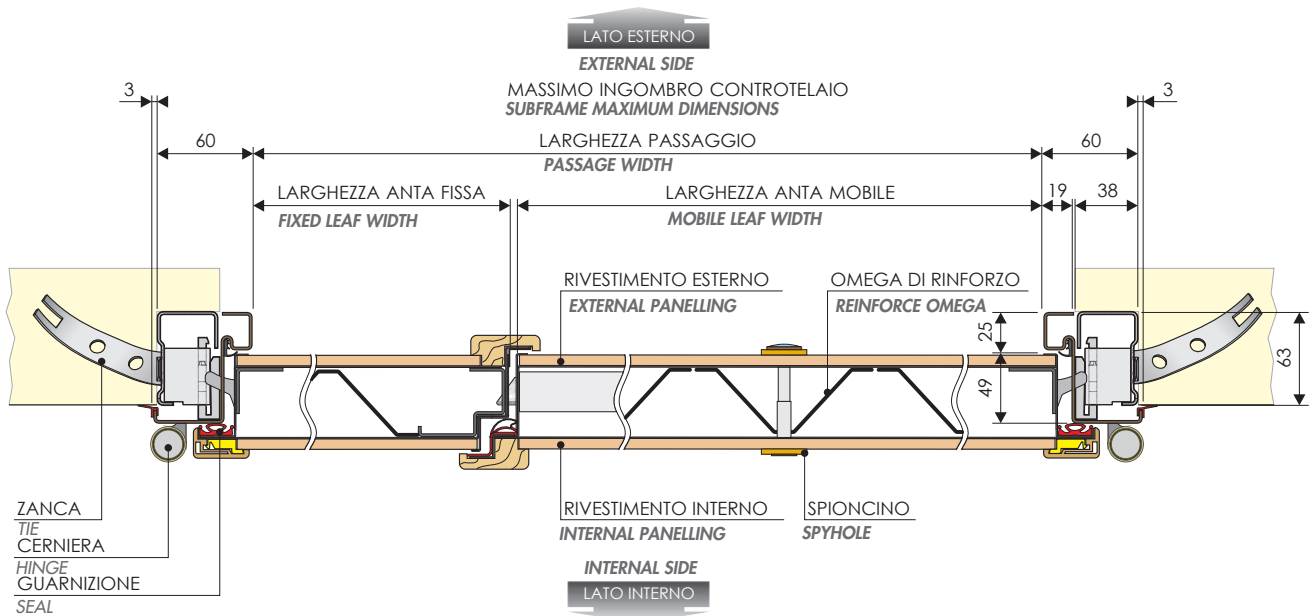

SPARTA MONOLAMIERA - SCHEMA TECNICO

SINGLE SHEET SPARTA - TECHNICAL DRAWING

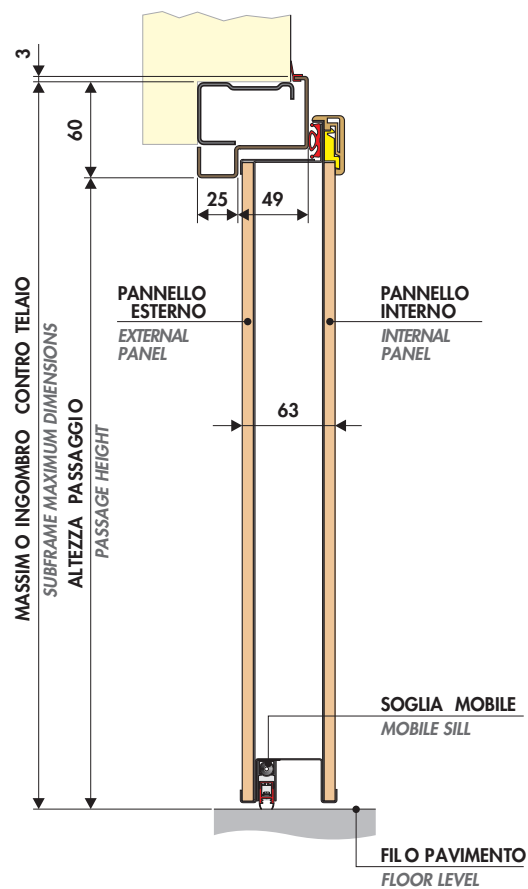
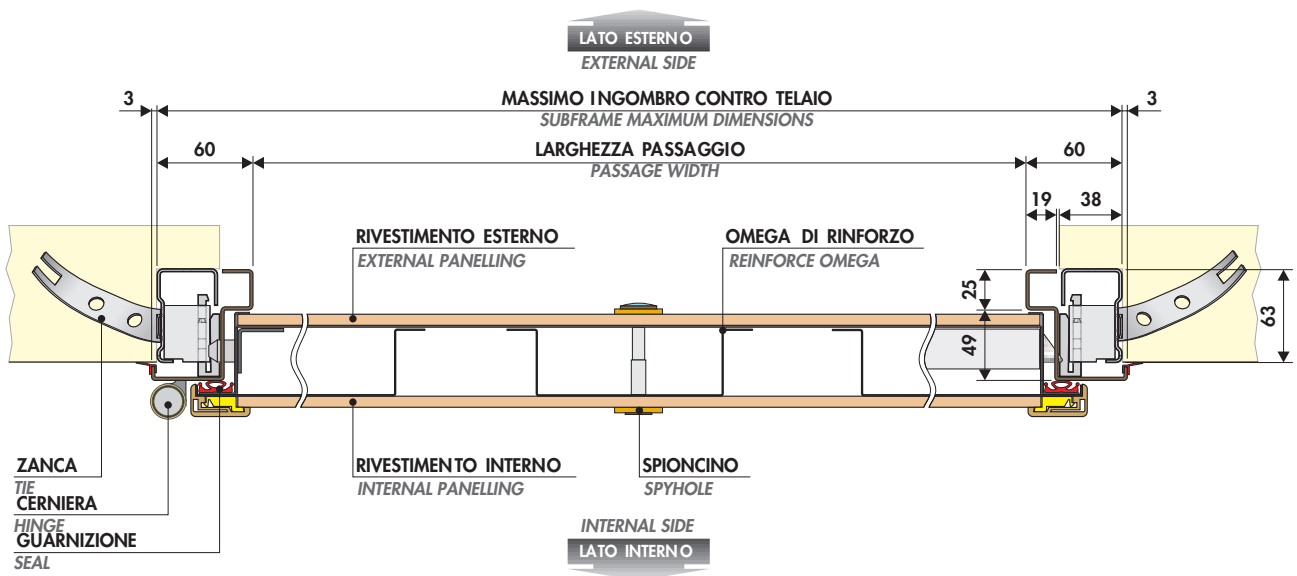



Note / Notes



Note / Notes



Note / Notes

